



No.1
2012



DSA800 series Spectrum Analyzer

- All-Digital IF Technology
- 9 kHz - 1.5 GHz Frequency Range
- Up to -135dBm Displayed Average Noise Level (DANL)
- -80dBc/Hz @ 10kHz Offset Phase Noise
- Total Amplitude Uncertainty < 1.5dB
- 100Hz Minimum Resolution Bandwidth (RBW)
- 1.5GHz Tracking Generator (DSA815-TG)
- Advanced Measurement functions (Option)
- EMI Filter & Quasi-Peak Detector Kit (Option)
- VSWR Measurement Kit (Option)
- Complete Connectivity: LAN, USB host, USB device, GPIB (option)
- 8 Inch WVGA (800x480) Display
- Compact Size, Light weight design

DSA800 series is one of RIGOL's compact size, light weight economic spectrum analyzers, the digital IF technology guarantees its reliability and performance to meet the most demanding RF applications.

Unique widescreen display, friendly interface and easy-to-use operations

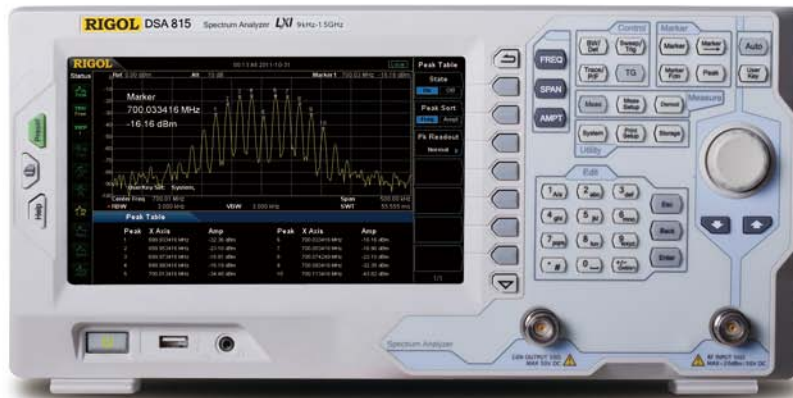

Product Dimensions: Width X Height X Depth = 361.6 mm x 178.8 mm x 128 mm Weight: 4.25kg (9.4lbs)

Benefits of Rigol's all digital IF design

1. The ability to measure smaller signals: on the basis of this technology, the IF filter enables smaller bandwidth settings, which greatly reduce the displayed average noise level.
2. The ability to distinguish between small signals by frequency: using the IF filter with the smallest bandwidth setting it is possible to make out signals with a frequency difference of only 100 Hz.
3. High precision amplitude readings: this technology almost eliminates the errors generated by filter switching, reference level uncertainty, scale distortion, as well as errors produced in the process of switching between logarithmic and linear display of amplitude when using a traditional analog IF design.
4. Higher reliability: compared with traditional analog designs, the digital IF greatly reduces the complexity of the hardware, the system instability caused by channel aging, and the temperature sensitivity that can contribute to parts failure.
5. High measurement speed: the use of digital IF technology improves the bandwidth precision and selectivity of the filter, minimizing the scanning time and improving the speed of the measurement.

► Features and Benefits

Distinguish the two nearby signals clearly with the 100Hz RBW

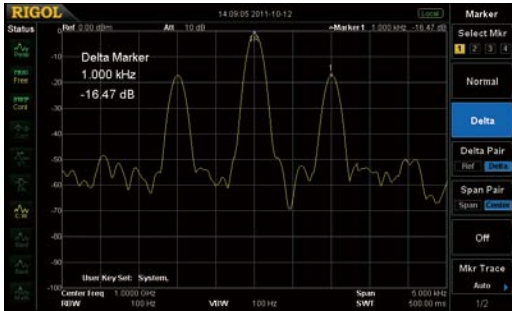

Zero span to demodulate the AM signal

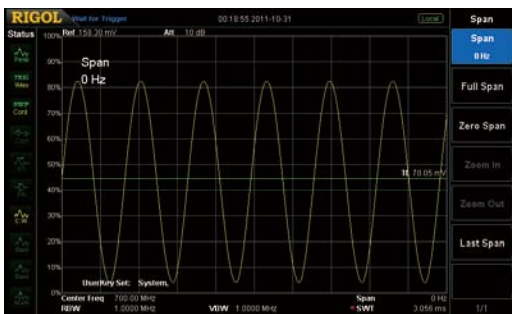

Measure lower than -130dBm signal with the standard Preampifier

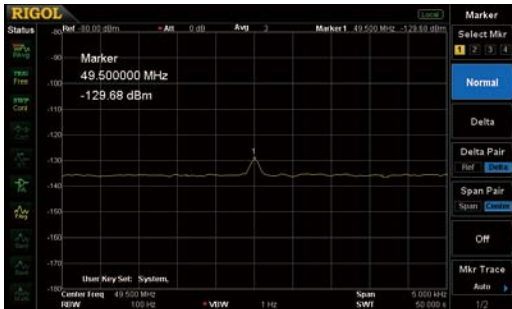

EMI Measurement (EMI Filter & Quasi-Peak & Pass_Fail)

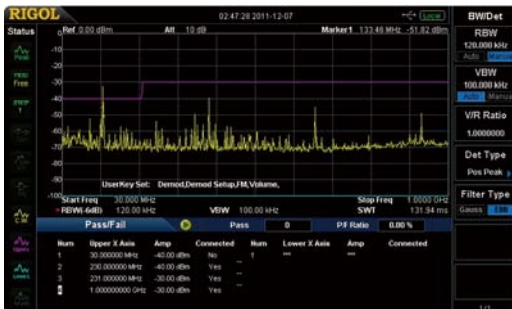

Compare the spectrums when change the RBW settings with different color trace

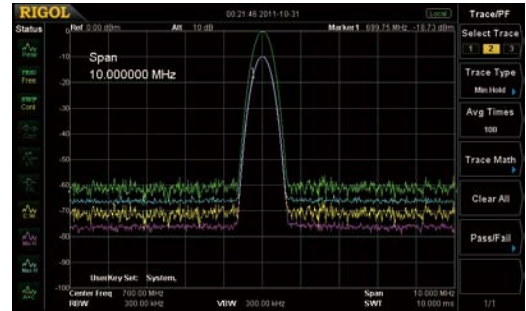

Readout the Spectrum Peak values with the Peak table function

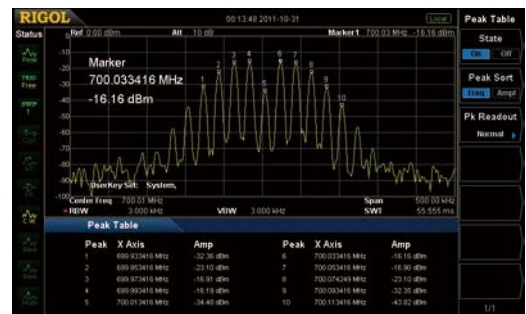

VSWR Measurement

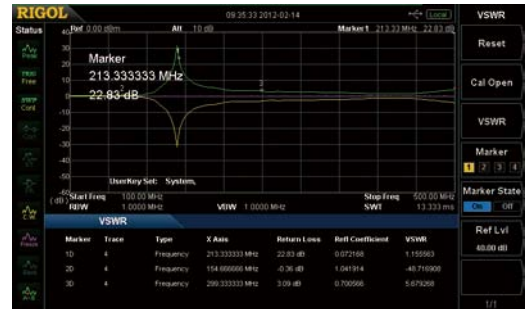

The GUI to control the RF Demo Kit (Transmitter) directly

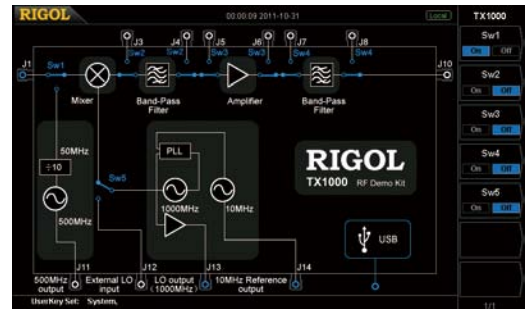

RF Demo Kit
(TX1000)

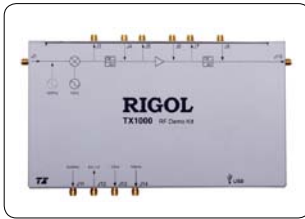

DSA Accessories Package
(DSA Utility Kit)



VSWR Bridge
(VB1020/VB1030)



Tracking Generator
(DSA815-TG)



Advanced Measurement Kit
(DSA800-AMK)



DSA PC Software
(Ultra Spectrum)

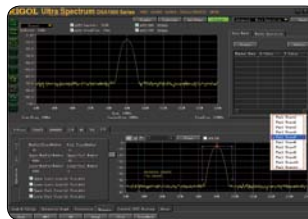

USB to GPIB Interface
Converter for Instrument
(USB-GPIB)



Rack Mount Kit
(DSA800-RMSA)



► Specifications

Specifications are valid after 30 minute warm up time with a valid calibration.

Typical value and nominal value are defined as follows.

- Typical value: defined as the specifications when the product is under specified conditions.
- Nominal value: defined as the approximate quantity in the application of the product.

Frequency

Frequency		
Frequency Range	DSA815	9 kHz to 1.5 GHz
Frequency Resolution		1Hz
Internal Frequency Reference		
Reference Frequency		10 MHz
Aging Rate		<2 ppm/year
Temperature Stability	20°C to 30°C	<2 ppm
Frequency Readout Accuracy		
Marker Resolution		span / (sweep points-1)
Marker Uncertainty		$\pm(\text{frequency indication} \times \text{frequency reference uncertainty} + 1\% \times \text{span} + 10\% \times \text{resolution bandwidth} + \text{marker resolution})$
Marker Frequency Counter		
Resolution		1 Hz, 10 Hz, 100 Hz, 1 KHz, 10 KHz, 100 KHz
Uncertainty		$\pm(\text{frequency indication} \times \text{frequency reference uncertainty} + \text{counter resolution})$

Note: Frequency Reference Uncertainty = (aging rate × period since adjustment + temperature drift).

Frequency Span		
Range	DSA815	0 Hz, 100 Hz to 1.5 GHz
Uncertainty		$\pm \text{span} / (\text{sweep points}-1)$
SSB Phase Noise		
Carrier Offset	10 kHz offset	<-80 dBc/Hz
Bandwidths		
Resolution Bandwidth (-3dB)		100 Hz to 1 MHz, in 1-3-10 sequence
Resolution Bandwidth (-6dB)	Opt	200 Hz, 9 kHz, 120 kHz
RBW Uncertainty		<5%, nominal
Resolution Filter Shape Factor (60dB: 3dB)		<5, nominal
Video Bandwidth (-3dB)		1 Hz to 3 MHz, in 1-3-10 sequence

Amplitude

Measurement Range		
Range	10 MHz to 1.5 GHz	DANL to +20 dBm
Maximum rated input level		
DC Voltage		50 V
CW RF Power	RF attenuation = 30dB	+20 dBm (100mW)
Max. Damage Level		+30 dBm (1W)

Note: When input level >+25dBm, the protection switch will be on.

Displayed Average Noise Level (DANL)		
0 dB RF Attenuation, RBW=VBW=100 Hz, Sample Detector, Trace Average \geq 50		
DANL (Preamplifier Off)	100 kHz to 1 MHz	<-90 dBm, typ. -110 dBm
	1 MHz to 1.5 GHz	<-110 dBm+6 x (f/1 GHz) dB, typ. -115 dBm
DANL (Preamplifier On)	100 kHz to 1 MHz	<-110 dBm typ. -130 dBm
	1 MHz to 1.5 GHz	<-130 dBm+6 x (f/1 GHz) dB, typ. -135 dBm

Level Display		
Logarithmic Level Axis		1 dB to 200 dB
Linear Level Axis		0 to Reference Level
Number of Display Points		601
Number of Traces		3 + Math Trace
Trace Detectors		Normal, Positive-peak, Negative-peak, Sample, RMS, Voltage Average, Quasi-peak
Trace Functions		Clear Write, Max Hold, Min Hold, Average, View, Blank
Units of Level Axis		dBm, dBmV, dB μ V, nV, μ V, mV, V, nW, μ W, mW, W

Frequency Response		
10 dB RF attenuation, relative to 50 MHz, 20 °C to 30 °C		
Frequency Response (Preamplifier Off)	100 kHz to 1.5 GHz	<0.7 dB
Frequency Response (Preamplifier On)	1 MHz to 1.5 GHz	<1.0 dB

Input Attenuation Switching Uncertainty		
Setting Range		0 to 30 dB, in 1 dB step
Switching Uncertainty	fc=50 MHz, relative to 10 dB, 20 °C to 30 °C	< 0.5 dB

Absolute Amplitude Uncertainty		
Uncertainty	fc=50 MHz, peak detector, preamplifier off, 10 dB RF attenuation, input signal=-10 dBm, 20 °C to 30 °C	\pm 0.4 dB

RBW Switching Uncertainty		
Uncertainty	100 Hz to 1 MHz, relative to 1 kHz RBW	<0.1 dB

Reference Level		
Range		-100 dBm to +20 dBm, in 1 dB step
Resolution	Log Scale	0.01 dB
	Linear Scale	4 digits

Level Measurement Uncertainty		
Level Measurement Uncertainty	95% confidence level, S/N>20 dB, RBW=VBW=1 kHz, preamplifier off, 10 dB RF attenuation,	<1.5 dB, nominal

	-50 dBm < reference level < 0, 10 MHz < f _c < 1.5 GHz, 20 °C to 30 °C	
--	----------------------------------------------------------------------------------------	--

RF Input VSWR		
10 dB RF Attenuation		
VSWR	1 MHz to 1.5 GHz	<1.5

Intermodulation		
Second Harmonic Intercept (SHI)		+40 dBm
Third-order Intermodulation (TOI)	f _c > 30 MHz	+10 dBm

1dB Gain Compression		
Total Power at Input Mixer	f _c ≥ 50 MHz, preamplifier off	>0 dBm

Note: Mixer power level (dBm) = input power (dBm) – input attenuation (dB).

Spurious Responses		
Image Frequency		<-60 dBc
Intermediate Frequency		<-60 dBc
Spurious Response, Inherent		<-88 dBm, typ.
Spurious Response, Others	Referenced to local oscillators, referenced to A/D conversion, referenced to subharmonic of first LO, referenced to harmonic of first LO	<-60 dBc
Input Related Spurious	Mixer level: -30 dBm	<-60 dBc, typ.

Sweep

Sweep		
Sweep Time Range	100 Hz ≤ Span ≤ 1.5 GHz Span=0 Hz	10 ms to 1500 s 20 μs to 1500 s
Sweep Time Uncertainty	100 Hz ≤ Span ≤ 1.5 GHz Span=0 Hz	5%, nominal 0.5%, nominal
Sweep Mode		Continuous, single

Trigger Functions

Trigger		
Trigger Source		Free run, Video, External
External Trigger Level		5 V TTL level

Tracking Generator (DSA815-TG)

TG Output		
Frequency Range		9 kHz to 1.5 GHz
Output Level		-20 dBm to 0 dBm, in 1 dB steps
Output Flatness	1 MHz to 1.5 GHz, referenced to 50 MHz	±3 dB

Inputs and Outputs

RF Input		
Impedance		50 Ω
Connector		N female

TG out		
Impedance		50 Ω
Connector		N female

10 MHz REF In / 10 MHz REF Out / External Trigger In		
Connector		BNC female
10 MHz REF In Amplitude		0 dBm to +10 dBm
10 MHz REF Out Amplitude		+3dBm to +10dBm
Trigger Voltage		5 V TTL level

USB		
	USB Host	
Connector		B plug
Protocol		Version 2.0
	USB Device	
Connector		A plug
Protocol		Version 2.0

General Specifications

Display		
Type		TFT LCD
Resolution		800 x 480 pixels
Size		8 inch
Colors		64k

Printer Supported		
Protocol		PictBridge

Remote Control		
USB		USB TMC
LAN Interface		10/100 Base-T, RJ-45, LXI Class C
IEC/IEEE Bus (GPIB)	with opt. USB-GPIB	IEEE 488.2

Mass Memory		
Mass Memory		Flash Disk (internal), USB Disk (not supplied)

Power Supply		
Input Voltage Range, AC		100 V - 240 V, nominal
AC Supply Frequency		45 Hz - 440 Hz,
Power Consumption		35 W typ. Max 50 W with all options.

Temperature		
Operating temperature range		5 °C to 40 °C
Storage temperature range		-20 °C to 70 °C

Dimensions		
	(W x H x D)	361.6 mm x 178.8 mm x 128 mm (14.2 inches×7.0 inches×5.0 inches)

Weight		
	With TG	4.25kg (9.4lbs)

► Ordering Information

	Description	Order Number
Mode	Spectrum Analyzer, 9 kHz to 1.5 GHz (with preamplifier)	DSA815
	Spectrum Analyzer, 9 kHz to 1.5 GHz, with preamplifier, with track generator, installed before leaving factory	DSA815-TG
Standard Accessories	Quick Guide (Hard Copy)	QGD03X00
	CDROM (User's Guide, Programming Guide)	-
	Power Cable	-
Options	EMI Filter & Quasi-Peak Detector Kit (DSA815 only)	DSA800-EMI
	VSWR Measure Kit (DSA815 only)	DSA800-VSWR
	VSWR Bridge (2 GHz)	VB1020
	VSWR Bridge (3 GHz)	VB1030
	DSA PC Software	Ultra Spectrum
	Advanced Measurement Kit	DSA800-AMK
	RF Demo Kit (Transmitter)	TX1000
	USB to GPIB Interface Converter for Instrument	USB-GPIB
	Rack Mount Kit	DSA800-RMSA
Optional Accessories	DSA Accessories Package Including: N-SMA Cable, BNC-BNC Cable, N-BNC Adapter, N-SMA Adapter, 75Ω-50Ω Adapter, Antenna 2 (900MHz/1.8GHz), Antenna 2 (2.4GHz)	DSA Utility Kit
Orderable Manuals (Hard Copy)	Quick Guide, Chinese& English	QGD03X00
	User's Guide, Chinese	UGD03000
	User's Guide, English	UGD03100
	Programming Guide, Chinese	PGD03000
	Programming Guide, English	PGD03100

RIGOL

Headquarter

RIGOL TECHNOLOGIES, INC.
No.156,Cai He Village,
Sha He Town,
Chang Ping District, Beijing,
102206 P.R.China
Tel:+86-10-80706688
Fax:+86-10-80705070
Email: info@rigol.com

USA

RIGOL TECHNOLOGIES,USA
INC.
7401 First Place, Suite N
Oakwood Village
OH 44146, USA
Toll free: 877-4-RIGOL-1 x111
Tel: 440-232-4488 x111
Fax: 440-232-4499
Email: beyondmeasure@
rigoltech.com

Europe

RIGOL TECHNOLOGIES EU,
GmbH
Lindbergh str. 4
82178 Puchheim, Germany
Tel: +49(0)89-8941895-0
Email: info-europe@
rigoltech.com

RIGOL® is the registered trademark of RIGOL Technologies, Inc. Product information in this document subject to update without notice. For the latest information about RIGOL's products, applications and services, please contact local RIGOL office or access RIGOL official website: www.rigol.com

May,2012